

# SIN12-7

# (12V7Ah)

SIN series is a general purpose battery with 5 years design life in float service . It meets with IEC and JIS standards .With up-dated AGM valve regulated technology and high purity raw materials, the SIN series battery has reliable standby service life. It is suitable for UPS/EPS, medical equipment, emergency light and security systems applications



## Specification

Cells Per Unit	6
Voltage Per Unit	12
Capacity	7Ah@20hr-rate to 1.75V per cell @25°C
Weight	Approx. 2.0 Kg(Tolerance±4%)
Max. Discharge Current	70A (5 sec)
Internal Resistance	Approx. 30 mΩ
Operating Temperature Range	Discharge: -20°C~60°C Charge: 0°C~50°C Storage: -20°C~60°C
Normal Operating Temperature Range	25°C±5°C
Float charging Voltage	13.7 to 13.9 VDC/unit Average at 25°C
Recommended Maximum Charging Current Limit	2.1 A
Equalization and Cycle Service	14.6 to 14.8 VDC/unit Average at 25°C
Self Discharge	SINERGY Valve Regulated Lead Acid (VRLA) batteries can be stored for more than 6 months at 25°C. Self-discharge ratio less than 3% per month at 25°C. Please charge batteries before using.
Terminal	Faston Tab 187(F1)
Container Material	A.B.S. UL94-HB, UL94-V0 Optional.



## Dimensions

Unit: mm Dimension: 151(L)×65(W)×100(H)

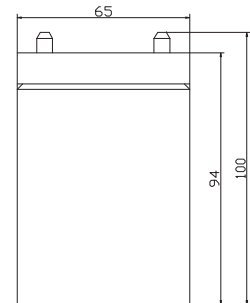
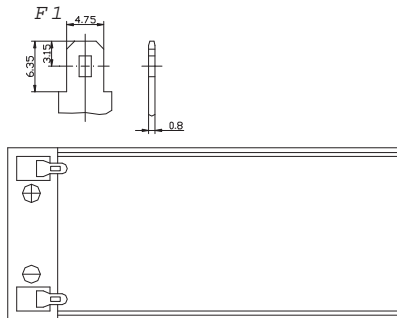
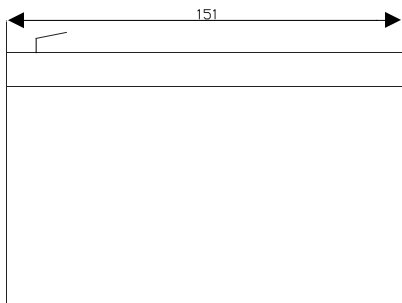

## CONSTANT CURRENT DISCHARGE CHARACTERISTICS : A(25°C)

F.V/Time	5MIN	10MIN	15MIN	30MIN	1HR	2HR	3HR	4HR	5HR	8HR	10HR	20HR
9.60V	26.23	17.20	12.81	6.818	4.322	2.643	1.742	1.418	1.166	0.768	0.665	0.356
10.0V	25.28	16.77	12.40	6.730	4.265	2.590	1.709	1.398	1.155	0.765	0.658	0.353
10.2V	23.80	15.94	12.05	6.628	4.224	2.562	1.694	1.384	1.148	0.758	0.648	0.343
10.5V	21.39	14.90	11.37	6.445	4.172	2.529	1.679	1.364	1.138	0.751	0.645	0.336
10.8V	19.17	13.90	10.73	6.232	4.114	2.508	1.659	1.317	1.133	0.748	0.634	0.322
11.1V	16.77	12.74	9.90	5.995	4.016	2.407	1.627	1.298	1.128	0.742	0.624	0.317

## CONSTANT POWER DISCHARGE CHARACTERISTICS : W(25°C)

F.V/Time	5MIN	10MIN	15MIN	30MIN	1HR	2HR	3HR	4HR	5HR	8HR	10HR	20HR
9.60V	284.5	188.6	141.3	78.04	51.67	31.14	20.82	16.98	13.97	9.195	7.964	4.270
10.0V	277.1	184.6	139.3	77.23	50.91	30.73	20.48	16.74	13.84	9.159	7.889	4.235
10.2V	263.5	177.3	137.5	76.56	50.53	30.46	20.31	16.58	13.76	9.090	7.787	4.126
10.5V	240.5	170.0	130.3	75.00	49.85	30.14	20.16	16.36	13.65	9.013	7.733	4.057
10.8V	217.0	159.1	123.1	73.22	49.20	29.92	19.92	15.81	13.58	8.974	7.615	3.894
11.1V	191.4	148.1	115.9	71.21	48.12	28.87	19.53	15.58	13.53	8.910	7.502	3.832

All mentioned values are average values(Tolerance±2%).

### Effect of temperature on long term float life

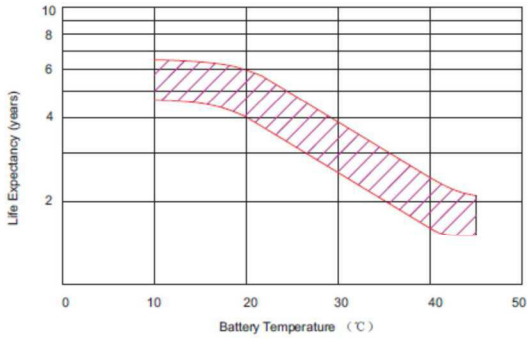

### Storage characteristic

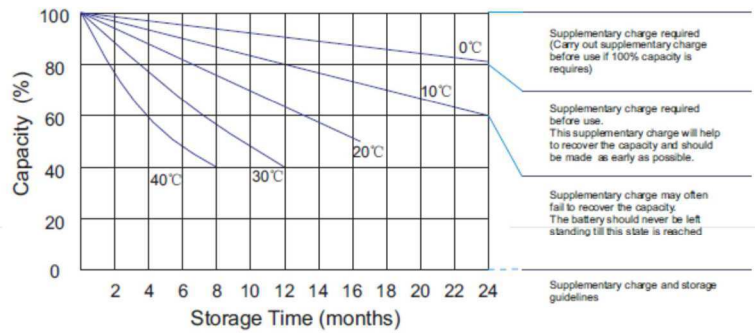

### Charge characteristic Curve for standby use

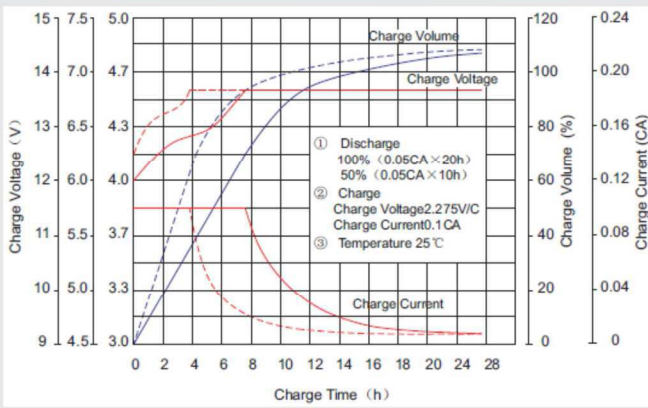

### Discharge characteristic Curve

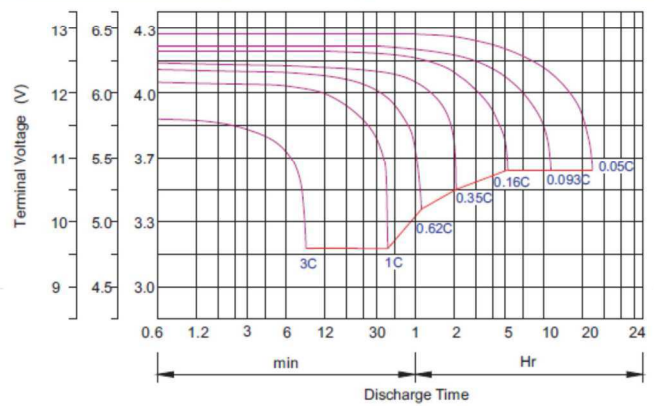

### Capacity Factors With Different Temperature

Battery Type		-20°C	-10°C	0°C	5°C	10°C	20°C	25°C	30°C	40°C	45°C
GEL Battery	6V&12V	50%	70%	83%	85%	90%	98%	100%	102%	104%	105%
	2V	60%	75%	85%	88%	92%	99%	100%	103%	105%	106%
AGM Battery	6V&12V	46%	66%	76%	83%	90%	98%	100%	103%	107%	109%
	2V	55%	70%	80%	85%	92%	99%	100%	104%	108%	110%

### Discharge Current VS. Discharge Voltage

Final Discharge Voltage V/cell	1.75V	1.70V	1.60V
Discharge Current (A)	(A) ≤ 0.2C	0.2C < (A) < 1.0C	(A) ≥ 1.0C

**Charge the batteries at least once every six months, if they are stored at 25°C.**

#### Charging Method:

Constant Voltage	-0.2Cx2h+2.4-2.45V/cellx24h, Max. Current 0.3C
Constant Current	-0.2Cx2h+0.1Cx12h
Fast	-0.2Cx2h+0.3Cx4h

Bolt	M5	M6	M8
Terminal	F3 F4 F13 F18 T25 T26	F8 F11 F12-1 F15	F5 F9 F10 F12 F14 F16
Torque	6 <sup>#</sup> 7N·m	8 <sup>#</sup> 10N·m	10 <sup>#</sup> 12N·m

### Maintenance & Cautions

#### Float Service:

※ Every month, recommend inspection every battery voltage.

※ Every three months, recommend equalization charge for one time.

#### Equalization charge method:

Discharge: 100% rate capacity discharge.

Charge: Max. current 0.3C, constant voltage 2.4-2.45V/Cell charge 24h.

※ Effect of temperature on float charge voltage: -3mV/°C/Cell.

※ Length of service life will be directly affected by the number of discharge

cycles, depth of discharge, ambient temperature and charging voltage.